

iStar sCMOS

Ultrafast Platform for Nanosecond Time-resolved Imaging and Spectroscopy

Key Specifications

- ✓ 5.5 megapixel sCMOS
- ✓ 50 fps full frame
- ✓ High dynamic range at full speed
- ✓ Integrated triple output DDG
- ✓ Photocathode QE up to 50%
- ✓ Integrate-On-Chip gating up to 500 kHz
- ✓ USB 3.0 interface

Key Applications

- ✓ Plasma studies
- ✓ Time-resolved Fluorescence & Photoluminescence
- ✓ Flow analysis
- ✓ Combustion/PLIF imaging
- ✓ Hyperspectral imaging
- ✓ Standoff chemical detection



Introducing iStar sCMOS

Superior **high-speed** acquisition performance



- ✓ 12-bit high-speed mode
- ✓ 2 times faster than the closest interline-based competitor at an equivalent field-of-view (and over 5 times faster with ROI)

Market Leading Ultrafast Acquisition Speeds

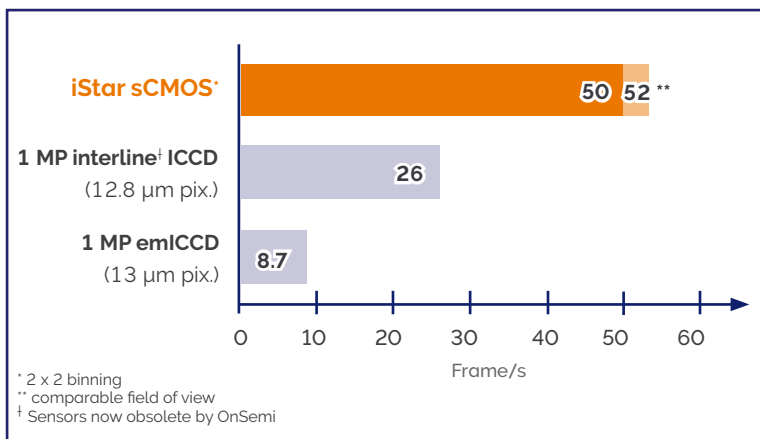

Image Array Size	Frame Rate 12-bit (16-bit)* ¹
2560 x 2160	50 (50)
2048 x 2048	52 (52)
2160 x 1800 (Ø 18 mm tube fit)	59 (59)
512 x 512	203 (203)
128 x 128	736 (736)
2560 x 8	4,008 (4,008)

Delivers

- ✓ **Faster characterisation of transient plasma, fluorescence or absorption behaviours**
- ✓ **NEW Faster characterization of spectroscopic phenomena and multi point experiment studies (multi-track)**
- ✓ **Faster Echellogram image capture for broadband LIBS-based applications**

Application Focus

Flow Analysis / Combustion

iStar sCMOS comfortably accommodates the 15 Hz imaging requirement of typical PLIF setups with extremely low noise floor and excellent dynamic range, nanosecond snapshots of the flame and high background light rejection.

Optical inter-frame down to 200 ns for time-gated PIV setups with a wide range of velocities.

Hyperspectral Imaging & multi-track spectroscopy

On-head FPGA functions can discriminate up to 256 individual channels (e.g. multi-leg fibre optic) with no acquisition rate sacrifice compared to CCDs. for time-gated PIV setups with a wide range of velocities.

Plasma Imaging

The high frame rate and < 2 ns gating of the iStar sCMOS allow faster reconstruction of plasma dynamics with extremely high temporal resolution.

Features & Benefits

Feature	Benefit
50 frames/s acquisition rates	Sustainable rate at full field-of-view, out-performs CCD and interline* based ns gated ICCDs with equivalent field-of-view.
16.6 x 14.0 mm sensor matrix	Large field of view, access more of the useful active area of Ø18 mm image intensifiers without the need for optical tapers.
2.4 e ⁻ read noise	Highest dynamic range even at the fastest frame rates, up to 5 times better performance than the closest interline-based competitor
12-bit and 16-bit modes	12-bit mode for smaller file size and absolute fastest frame rates, 16-bit for full dynamic range.
Up to 32-bit data transmission to PC	On-head intelligence to preserve dynamic range in extensive pixel binning, or high intensity pixel binning scenarios.
Optical inter-frame down to 300 ns	Ideal for PIV-type applications requiring fast dual images snapshots with high background rejection or supersonic flow analysis. The true Global Shutter mode facilitates an optical inter-frame gap down to 100 ns, although the intensifier phosphor decay time is the limiting factor. The decay time of a fast P46 phosphor is typically 200 ns (@ 10% intensity).
TE cooling down to 0°C	Efficiently minimizes dark current noise for acquisitions requiring longer sensor exposure time, e.g. integrate-on-chip mode.
High QE Gen 2 & 3 image intensifiers	Superior photon capture, with peak QE up to 50% and spectral coverage from 120 to 1,100 nm.
True optical gating < 2 ns	Billionth of a second time-resolution for accurate transient phenomena study.
Low jitter, on-board Digital Delay Generator (DDG™)	Highest gating timing accuracy with lowest propagation delay. Software controlled 3x triggering outputs with 10 ps setup accuracy for complex experiment integration.
500 kHz sustained photocathode gating (3.3 MHz Burst Mode)	Maximizes signal-to-noise ratio in high repetition rate pulse laser-based applications. Burst mode allows gate pulse separation down to 300 ns for time-resolved PIV mode.
Photocathode EBI minimization	Dry gas purge interface for further efficient EBI reduction.
Intelligate™	Intelligent and accurate MCP gating for better than 1:10 ⁸ shuttering efficiency in the UV (Gen 2 image intensifier).
USB 3.0 interface	Super-fast data transfer at 40 fps full frame with a plug-and-play, user-friendly interface – optical extenders available for operation up to 100 m.
GPU Express	Simplify and optimize data transfers from camera to Graphical Processing Unit (GPU) card to facilitate accelerated GPU processing as part of the acquisition pipeline.
Integrated in EPICS	Ease of operation in EPICS software-based facilities such as partner particle accelerators and other large scientific experiments.
2 year warranty	Reliability and guaranteed performance over time.

*Sensors now obsolete by OnSemi

Spectroscopy Modes

On-head asymmetric binning and multi-track	On-board intelligence delivering Spectroscopists-friendly spectra and multi-track data prior to transfer through USB interface. Upfront data size reduction and easier user data processing.
Selectable bit-depth up to 32-bit	Preserve dynamic range in extensive on-head binning scenarios. User-selectable data bit depth to be transmitted over the camera interface, up to 32-bit.

Technical Specifications^{•2}

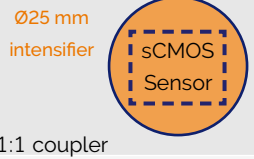
Sensor type	Front-Illuminated Scientific CMOS	
Sensor matrix	2560 x 2160 pixels (W x H), 6.5 μm pixel size	
	 <p>Ø18 mm intensifier sCMOS Sensor 1:1 coupler</p>	 <p>Ø25 mm intensifier sCMOS Sensor 1:1 coupler</p>
Sensor size	16.6 x 14.0 mm 21.8 mm diagonal	
Pixel well depth (e ⁻)	30,000	
Read noise (e ⁻) median [rms] at available pixel readout rates ^{•3}	@ 200 MHz 2.3 [2.5] @ 560 MHz 2.4 [2.6]	
Minimum cooling temperature ^{•4} [dark current, e ⁻ /pixel/s]	Ø18 mm photocathode	Ø25 mm photocathode
air cooled	0°C [0.18]	0°C [0.18]
liquid cooled	0°C [0.18]	0°C [0.18]
Sensor linearity (% maximum) ^{•5}	Better than 99.8%	
Data range	12-bit (fastest speed) and 16-bit (maximum dynamic range)	
Pixel binning	On-head, pre-defined options 2x2, 4x4 ... or flexible configuration setup	
Region of Interest	Minimum channel height of 8 rows	
Interface option	USB 3.0	
Internal memory	1 GB	

Camera and Internal Digital Delay Generator (DDG) Inputs/Outputs

Gate pulse delay & width	Adjustable from 0 ns to 10 s in 10 ps steps
Trigger Outputs	
Output A, B and C	+5 V CMOS level with 50 Ω source impedance; can drive 5V into a non-terminating load or 2.5V into 50 Ω load; output synchronized triggers for auxiliary equipment, e.g. lasers, flash lamps, National Instrument™ hardware Individual delays control from 0 ns to 10 s in 10 ps steps Configurable Polarity
Fire	5 V CMOS level reference signal for beginning and end of individual sensor exposure
Arm monitor	5 V CMOS level reference signal to indicate when system is ready to accept external triggers. Signal goes high when system is ready to accept external triggers (after a readout has finished or sooner if in overlap mode) and goes low when the exposure is finished
Gate & output A, B and C jitter	35 ps rms (relative to external trigger or to each other)
Trigger Inputs	
External trigger	Trigger input for sensor and Digital Delay Generator Up to 500 kHz for Integrate-On-Chip mode
Direct gate	TTL input for exact external control of photocathode width and timing with smallest insertion delay.
Additional Controls	
Gate monitoring	AC coupling from photocathode to monitor exact photocathode on/off switching and timings
Insertion delay	< 19 ns in direct gate operation

How the sCMOS sensor is used in the different modes

The diagrams below illustrate how the sCMOS sensor array is used for the different modes:

Imaging Mode

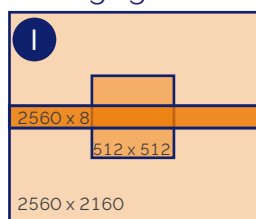

The array size may be defined for either resolution, or maximum speed.

Spectroscopy Mode

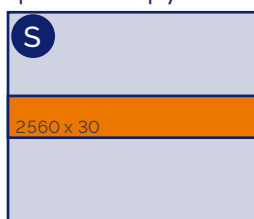

A vertically binned track is centred on the sensor enabling the maximum spectral rate to capture dynamic events.

Multi-track Mode

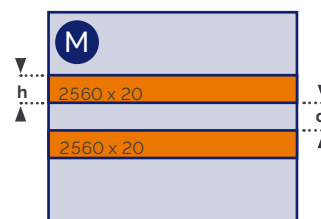

Up to 256 vertically binned tracks can be used for multi-track analysis without sacrificing speed.

I Imaging Mode

Frame rate table - 12-bit (16-bit) **

Array Size (W x H)	Frame Rate*
2560 x 2160	50 (50)
2048 x 2048	52 (52)
1920 x 1080	98 (98)
512 x 512	203 (203)
128 x 128	736 (736)
2560 x 8	4,008 (4,008)

* 2 x 2 binning.

S Spectroscopy Mode

Vertically binned tracks 12-bit & 16-bit*

Array Size (W x H)	Frame Rate
any x 8	4,008
any x 12	3,491
any x 16	3,092
any x 31	2,122
any x 77	1,093
any x 100	909
any x 128	736
any x 154	618
any x 462	224
any x 512	203
any x 1040	102
any x 1080	98
any x 2048	52

M Multi-track Mode

Vertically binned tracks 12-bit & 16-bit **

Number of tracks (centred vertically)	Track height (h, pixels)	Tracks separation (d, pixels)	Frame Rate
2	12	12	1,967
2	20	20	1,370
2	154	77	265
20	12	12	222
20	20	20	135
50	12	12	89
50	20	20	54
256	8	0	52

GPU Express - Optimise Data Flow-Rates



The Andor GPU Express library has been created to simplify and optimise data transfers from camera to a CUDA-enabled Nvidia Graphical Processing Unit (GPU) card to facilitate accelerated GPU processing as part of the acquisition pipeline. GPU Express integrates easily with SDK3 for Windows, providing a user-friendly but powerful solution for management of high bandwidth data flow challenges; ideal for data intensive applications such as Light Sheet Microscopy, Super-Resolution Microscopy and Adaptive Optics.

- ✓ Enhanced convenience, afforded by simple, optimised GPU data management
- ✓ Optimal data throughput
- ✓ Superb, easily accessible documentation and examples.

Specifications: Gen 2 Image Intensifiers*²

Photocathode model	18*-03 (P43) 18*-04 (P46)	18*-05 †	18H-13 (P43) 18H-14 (P46)	18H-83 (P43) 18H-84 (P46)	18*-E3 (P43) ⁶ 18*-E4 (P46) ⁶	25*-03 (P43) 25*-04 (P46)
Useful aperture	Ø18 mm (Ø25 mm available- contact Andor for information)		Ø18 mm only			Ø25 mm
Input window	Quartz	MgF ₂	Quartz	Quartz	Quartz	Quartz
Photocathode type	W-AGT	W-AGT	WR	UW	WE-AGT	W-AGT
Minimum guaranteed QE at room temperature* ⁷	13.5%	11%	7%	20%	15%	14%
Typical peak QE at room temperature* ⁷	>18%	>15%	>13.5%	>25%	>22%	>16%
Wavelength range (nm)	180 - 850	120 - 850	180 - 920	180 - 850	180 - 850	180 - 850
Phosphor type [decay time to 10%] Standard Optional**	P43 [2 ms] P46 [200 ns]					
Image intensifier resolution limit* ⁸ P43 (Standard) P46 (Optional)	25 µm 30 µm [I-04 model]	25 µm 30 µm	25 µm 30 µm [I-14 model]	25 µm 30 µm [I-84 model]	25 µm 30 µm [I-E4 model]	35 µm 40 µm [I-04 model]
Minimum optical gate width (ns)* ^{9,10} U (Ultrafast) F (Fast) H (High QE)	< 2 < 5 -	< 5 < 10 -	- - < 50	- - < 100	< 2 < 5 -	< 3 < 7 -
Maximum relative gain* ¹¹	> 1000 (P43) > 500 (P46)	> 1000	>850 (P43) >400 (P46)	>500 (P43) >250 (P46)	>300 (P43) >150 (P46)	>1000 (P43) >500 (P46)
Maximum photocathode repetition rate (with Intelligate™ OFF)	500 kHz (continuous)					
Maximum photocathode repetition rate n(with Intelligate™ ON)	5 kHz (continuous)					
Equivalent Background Illuminance (EBI)	< 0.2 photoe ⁻ /pix/sec		< 0.4 photoe ⁻ /pix/sec		< 0.2 photoe ⁻ /pix/sec	

* Substitute with appropriate gate width option, e.g. 18*-03 (please refer to page 9 for detailed ordering information)

** All photocathode types can be combined with a fast-decay P46 phosphor – please contact your local Andor representative for further information

† Available with VUV-compatible spectrograph interface

Quantum Efficiency Curves for Gen 2 Image Intensifiers*⁷

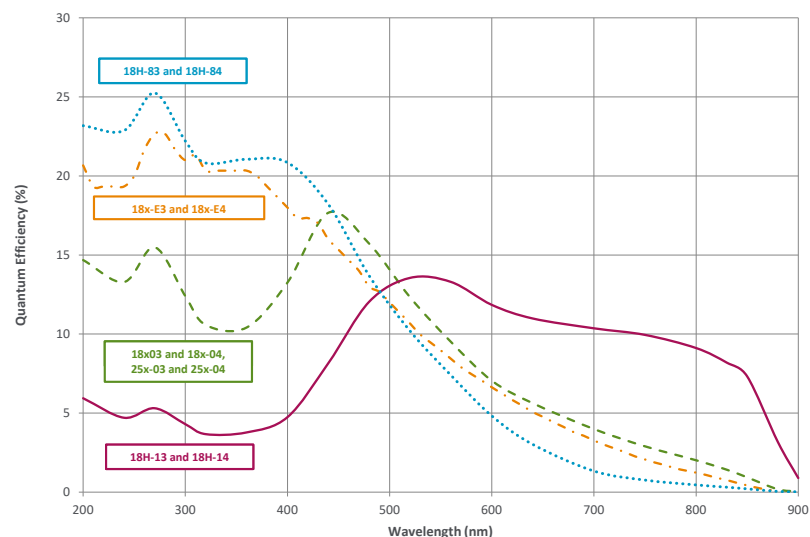

Specifications: Gen 3 Image Intensifiers²

Photocathode model	18'-63 (P43) 18'-64 (P46)	18'-73 (P43) 18'-74 (P46)	18'-93 (P43) 18'-94 (P46)	18'-A3 (P43) 18'-A4 (P46)
Useful aperture	Ø18 mm (Ø25 mm options also available except -93 model- contact Andor for information)			
Input window	Glass	Glass	Glass	Glass
Photocathode type	HVS	VIH	NIR	EVS
Minimum guaranteed QE at room temperature ^{•7}	38%	23%	0.10%	35%
Typical peak QE at room temperature ^{•7}	> 50%	> 30%	> 5%	> 40%
Wavelength range	280 - 760 nm	280 - 910 nm	380 - 1090 nm	280 - 810 nm
Phosphor type [decay time to 10%] Standard Optional**	P43 [2 ms] P46 [200 ns]			
Image intensifier resolution limit ^{•8} P43 (Standard) P46 (Optional)	30 µm 35 µm [-64 model]	30 µm 35 µm [-74 model]	30 µm 35 µm [-94 model]	30 µm 35 µm [-A4 model]
Minimum optical gate width (ns) ^{•10} U (Ultrafast) F (Fast)	< 2 < 5	< 2 < 5	< 3 < 5	< 2 < 5
Maximum relative gain ^{•11}	> 200 (P43) > 100 (P46)			
Maximum photocathode repetition rate (with Intelligate™ OFF)	500 kHz (continuous)			
Maximum photocathode repetition rate (with Intelligate™ ON)	5 kHz (continuous)			
Equivalent Background Illuminance (EBI)	< 0.1 photoe ⁻ /pix/sec	< 0.3 photoe ⁻ /pix/sec	< 2 photoe ⁻ /pix/sec	< 0.2 photoe ⁻ /pix/sec

[•] Substitute with appropriate gate width option, e.g. 18'-63 (please refer to page 9 for detailed ordering information)

^{••} All photocathode types can be combined with a fast-decay P46 phosphor – please contact your local Andor representative for further information

Quantum Efficiency Curves for Gen 3 Image Intensifiers⁷

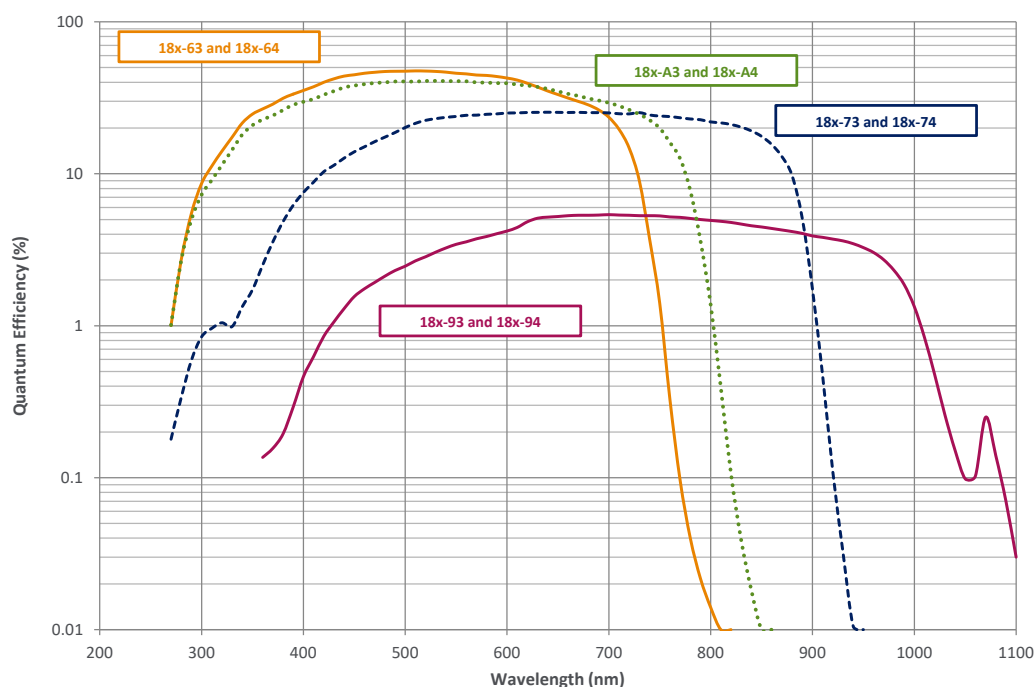

Intelligent gating modes

Integrate-On-Chip: 500,000 times more signal per 1 sec sensor exposure

The iStar's Integrate-On-Chip (IOC) mode enables accumulation of useful signal from laser-induced phenomena at frequencies up to 500 kHz, providing greatly improved signal-to-noise, and minimising experiment time. The latter greatly benefits setups where photobleaching-sensitive biological samples are probed. This translates into the possibility to accumulate 500,000 times more signal per 1 second sensor exposure time.

Integrate-On-Chip is fully software-configurable and can be used through extensive kinetic series involving up to 1,000 pre-programmed incremental delays from laser trigger for unrivalled combination of sensitivity and ultra-precise transient phenomena analysis.

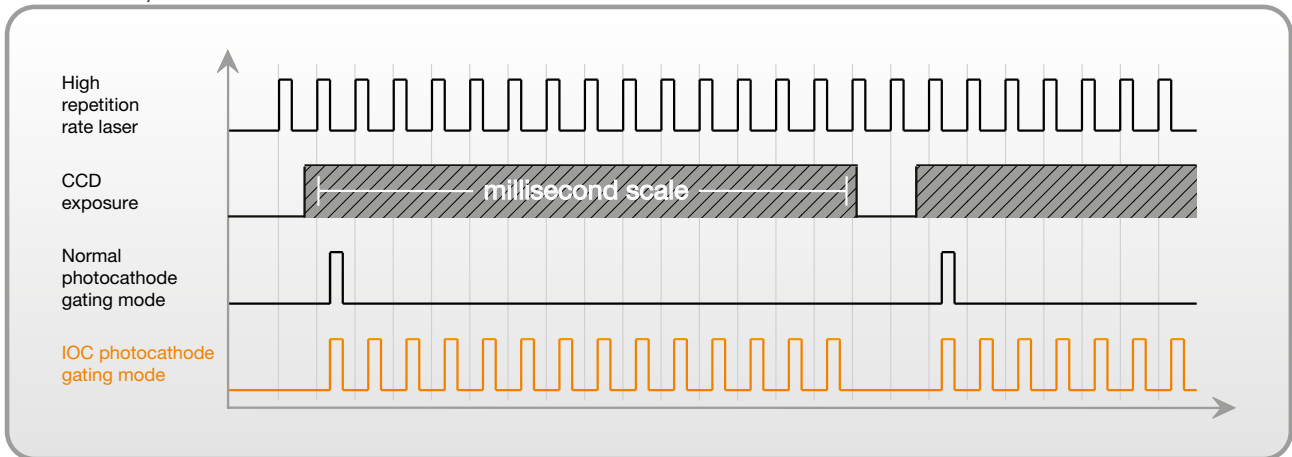

Intelligate™: Superior gating in the UV-VUV region

One of the key functions of an image intensifier is to provide high optical shuttering (ON/OFF) ratio.

By switching photocathode voltage to a higher or lower level relative to the MCP voltage, photoelectrons can be either directed towards or repelled from the MCP to avoid detection. ON/OFF values of $1:10^8$ are typically measured for Visible/NIR incident light on the photocathode.

However photocathode "leakage" becomes more pronounced in the UV-VUV region (< 300 nm), where more energetic photons have a greater probability to go through the photocathode turned "OFF", reach the MCP to generate an electron that can be detected. This can lead to shuttering efficiency as low as $1:10^4$.

Andor's exclusive Intelligate™ simultaneously gates the photocathode and the MCP. The ultra fast rising edge of the MCP gate pulse switches on the correct potential in a nanosecond timeframe, coinciding precisely with the photocathode gating pulse. This enables ON/OFF ratios as high as 10^8 in the UV-VUV region.

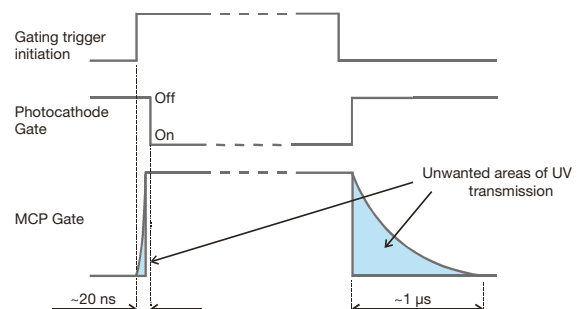
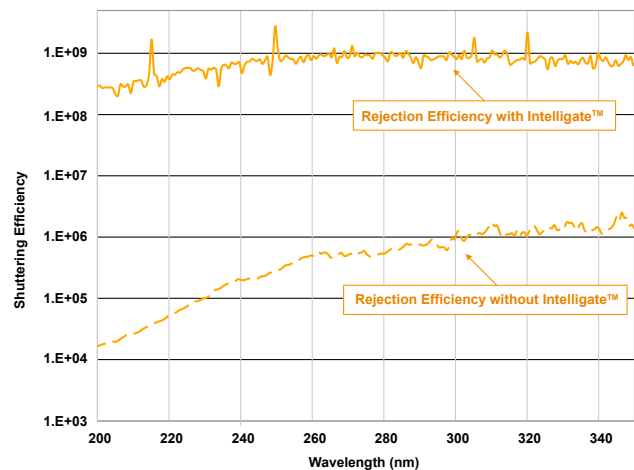

Creating the optimum product for you



ISTAR-SCMOS-18-F-03 example shown

Step 1. Choose the intensifier diameter



Intensifier diameter	Code
Ø 18 mm	18
Ø 25 mm	25

Please contact Andor regarding Ø 25 mm options.

Step 2. Choose a minimum gating speed



Gating speed	Code
High QE, slow gating	H
Fast Gating	F
Ultra Fast Gating	U

Step 3. Select an image intensifier option



Gen 2 Intensifier option	P43 phosphor	P46 phosphor	Gen 3 Intensifier option	P43 phosphor	P46 phosphor
	W-AGT photocathode	03		04	HVS photocathode
W-AGT photocathode, MgF ₂	05	-	VIH photocathode	73	74
WR photocathode	13	14	NIR photocathode	93	94
UW photocathode	83	84	EVS photocathode	A3	A4
WE-AGT photocathode	E3	E4	WE-AGT	E3	E4

Step 4. Select the required accessories and adapters



Description	Order Code
C-mount lens adaptor	ACC-LM-C
F-mount lens adaptor	ACC-LM-NIKON-F
UV-VIS 105mm SLR lens, 250 - 650 nm transmission, F-mount	OL-AF10-F45-#UV2
Oasis 160 Ultra compact chiller unit (tubing to be ordered separately)	ACC-XW-CHIL-160
6 mm tubing options for ACC-XW-CHIL-160 (2x2.5 m or 2x5 m lengths)	ACC-6MM-TUBING-2X2.5/ ACC-6MM-TUBING-2X5M
1°C to BNC cable for Kymera and Shamrock shutter control	ELC-05323
Metric Bracket, converts ¼-20 mounting points to M6	ACC-ISTAR-METRIC ADP
15 m active USB 3.0 connector cable (power supply not required)	ACC-ASE-06887
50 m fibre optic USB 3.0 extender solution including power supply	ACC-ASE-08762
100 m fibre optic USB 3.0 extender solution including power supply	ACC-ASE-07860

Step 5. Select the required software



The iStar sCMOS requires at least one of the following software options:

Solis for Time-Resolved A 32-bit and fully 64-bit enabled application for Windows (8, 8.1 and 10) offering rich functionality for data acquisition and processing. AndorBasic provides macro language control of data acquisition, processing, display and export.

Andor SDK3 A software development kit that allows you to control the Andor sCMOS cameras from your own application. Available as 32/64-bit libraries for Windows (8, 8.1 and 10) and Linux. Compatible with C/C++, LabView and Matlab.

GPU Express Andor GPU Express library has been created to simplify and optimize data transfers from camera to a CUDA-enabled NVidia Graphical Processing Unit (GPU) card to facilitate accelerated GPU processing as part of the acquisition pipeline. Integrates easily with Andor SDK3 for Windows.

Product drawings

Dimensions in mm [inches]
Weight: 4.5 kg [9 lb 15 oz]

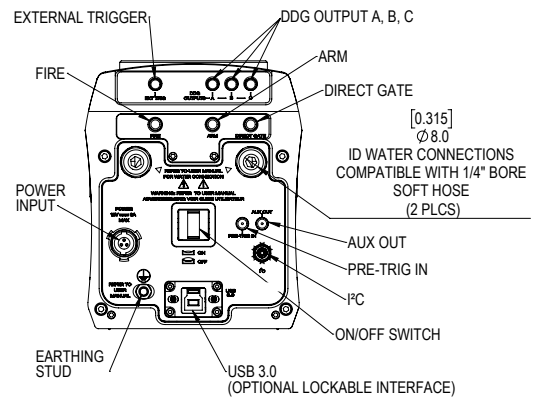
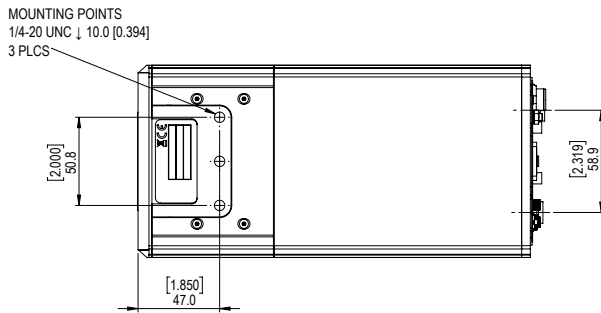
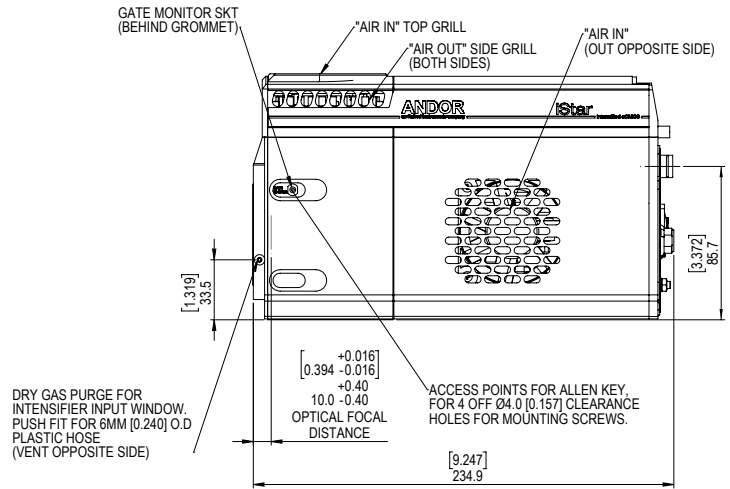
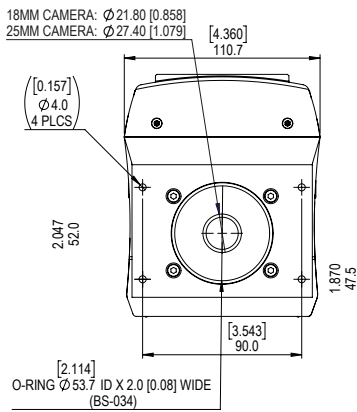
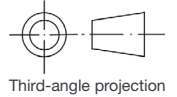

Connecting to the iStar sCMOS

Camera Control

Connector type: USB 3.0*12

Logic Input / Output

Connector type: SMA, provided with SMA - BNC cable

6x outputs: FIRE pulse, Output A, B, C from DDG, ARM, and Aux Out. 3x inputs: Camera trigger from 3rd party source (External Trigger), direct gate for direct external control of intensifier gating, and Pre-Trigger

I²C connector

Compatible with Fischer SC102A054-130, pin-outs as follow:

1 = Shutter (5V CMOS level with 50 Ω impedance), 2 = I²C Clock (5V), 3 = I²C Data (5V), 4 = +5 Vdc, 5 = Ground

Gate Monitor

1x output: AC coupling to photocathode

Aux Out (external mechanical shutter output)

Configured by default to a 5V CMOS level with 50 Ω impedance shutter output for controlling Andor Shamrock spectrograph mechanical shutters

Pre-trigger

Controls the sensor exposure in 'external exposure mode'. Also available in 'external trigger mode' as an optional exclusive trigger to the sensor.

Regulatory Compliance & Power Supply Information

Regulatory Compliance

- RoHS compliant
- EU EMC Directive
- EU LV Directive
- IEC 61010-1 CB Scheme

External Power Supply Compliance

- UL-certified for Canada and USA
- Japanese PSE Mark

Power Supply Requirements

- Power: +12 VDC \pm 5% @ 5 A typ. / 9 A max.
- Ripple: 120 mV peak-peak 0 - 20 MHz
- 100 - 240 VAC, 43 - 67 Hz External power supply

Power Consumption:

- Camera + External Power Supply (Typ./ Max.): 69 W/ 124 W
- Camera Only (Typ./ Max.): 60 W/ 108 W

Our Cameras for Spectroscopy

Spectroscopy-based diagnostics in the fields of Material Science, Chemistry, Life Science or Fundamental Physics & Optics rely on the capture and analysis of optical and chemical signatures with a high degree of precision.

Andor's range of detectors offer a wide range of sensitivity, time-resolution and sensor formats to best suit specific experimental conditions from UV to SWIR, nanosecond to hours time resolution, high photon flux to single photon with super dynamic range and resolution.

High Sensitivity & Dynamic Range



- ✓ Long exposure
- ✓ High sensitivity UV-SWIR
- ✓ Large pixel well depths
- ✓ High resolution matrix

iDus CCD & InGaAs | Newton CCD & EM

Spectrographs & Accessories



- ✓ High modularity
- ✓ High resolution
- ✓ Intelligent motorisation
- ✓ Broadband & high resolution Echelle

Shamrock | Kymera | Mechelle

kHz Spectral Rates



- ✓ μ s to ms time-resolution
- ✓ High sensitivity down to single photon
- ✓ High resolution matrix

Newton CCD & EMCCD | iXon EMCCD |
Zyla sCMOS | Marana sCMOS

Extended Multi-fibre Spectroscopy

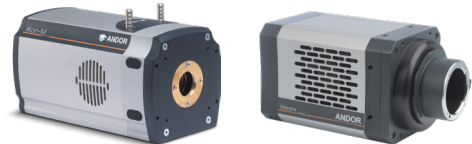

- ✓ Large area sensors
- ✓ Ultrafast sCMOS and EMCCD options
- ✓ High sensitivity down to single photon

iKon-M CCD | iXon EMCCD | Zyla sCMOS |
Marana sCMOS | iStar CCD & sCMOS

Learn more about our detector range [here](#).

Order Today

Need more information? At Andor we are committed to finding the correct solution for you. With a dedicated team of technical advisors, we are able to offer you one-to-one guidance and technical support on all Andor products.

For a full listing of our local sales offices, please see: andor.com/contact

Our regional headquarters are:

Europe

Belfast, Northern Ireland
Phone +44 (28) 9023 7126
Fax +44 (28) 9031 0792

North America

Concord, MA, USA
Phone +1 (860) 290 9211
Fax +1 (860) 290 9566

Japan

Tokyo
Phone +81 (3) 6732 8968
Fax +81 (3) 6732 8939

China

Beijing
Phone +86 (10) 5884 7900
Fax +86 (10) 5884 7901



Items shipped with your camera

- 1 x USB 3.0 PCIe Card and 1 x 3 m USB 3.0 cable (Type A to B)
- 1x Gate Monitor cable
- 2x 2 m BNC to SMA cable
- 1x Power supply with mains cable
- 1x Quick Start Guide
- 1x User guides in electronic format
- 1x Individual performance booklet

Minimum Computer Requirements:

- 3 GHz Quad Core
- 4GB RAM (increase RAM if to be used for continuous data spooling)
- Hard Drive: Minimum 450 MB/s continuous write
- PCI Express x4 or greater
- Windows (8, 8.1 or 10) or Linux
- *See technical note entitled: 'PC Specifications for sCMOS'

Operating and Storage Conditions

- Operating Temperature: 0°C to 40°C ambient
- Relative Humidity: < 70% (non-condensing)
- Storage Temperature: -20°C to 55°C

Power Requirements

- Please refer to page 10

Footnotes: Specifications are subject to change without notice

1. Note that the write speed of the PC hard drive can impose a further restriction to achieving sustained kinetic series acquisition. All frame rates specified are given for non-overlap mode.
2. Figures are typical unless otherwise stated.
3. Readout noise is for the entire system and is taken as a median over the sensor area excluding any regions of blemishes. It is a combination of sensor readout noise and A/D noise.
4. Dark current measurement is taken as a median over the sensor area excluding any regions of blemishes.
5. Linearity is measured from a plot of Signal vs. Exposure Time over the full dynamic range.
6. The On/Off ratio for the 'E3 and E4' image intensifier in the UV with MCP gating is typically 10^5 .
7. Typical photocathode Quantum Efficiency and input window transmission as measured by the tube manufacturer.
8. Typical resolution of the image intensifier tube only, not the overall resolution of the system. As a rough guide, the smallest resolvable FWHM feature will be approximately 4x the sensor pixel size. This is a very important consideration for optical resolution calculations in spectrograph-based systems.
9. Gen 2 High QE (H) option - Photocathode QE is inherently linked to the gating speed of the intensifier. High QE option (H) offers higher peak QE than Ultrafast (U) or Fast (F) intensifiers, while exhibiting minimum gating speed one order of magnitude slower.
10. Actual measured minimum optical gating of the photocathode, reflecting not only the electrical pulse width applied to the photocathode but also its inherent iris time.
11. Gain is software-selectable through a 12-bit DAC and varies exponentially with DAC setting. Value refers to the ratio of max to min intensifier gain as measured for individual cameras. Actual optical gain (counts/ photoe⁻) for a DAC setting is accessed by the multiplication of the relative gain (at that DAC value) by the minimum system gain (at DAC = 0, sCMOS e⁻/photoe⁻) and divided by the sCMOS sensitivity (sCMOS e⁻/count). Sensitivities are individually measured and reported for each system.
12. USB 3.0 connection should work with any modern USB 3.0 enabled PC/laptop (provided hard drives or RAM is sufficient to support data rates) as every USB 3.0 port should have its own host controller. iStar sCMOS also ship with a USB 3.0 PCIe card as a means to add a USB 3.0 port to an older PC, or as a diagnostic aid to interoperability issues or to ensure maximum speed.



µManager



Windows is a registered trademark of Microsoft Corporation

L1STARSCMOSSS 0321 R1